



Tyrolit Wall saw blades

Selection of drive holes

English

The Tyrolit Group

Tyrolit is one of the world's leading manufacturers of grinding and dressing tools and is also a system provider for the construction industry.

Since 1919, our innovative tools have been making an important contribution to technological development in numerous industries. Tyrolit offers tailored grinding solutions for a varied range of applications and a comprehensive assortment of standard tools for customers all over the world.

The family-owned company based in Schwaz, Austria, combines the dynamic strengths of the Swarovski Group with over a hundred years of commercial and technological experience.



Tyrolit headquarters in Schwaz (Austria)

Facts & figures



80,000+
products



29
production locations



4,000+
employees worldwide



36
sales locations



500+
international patents

Sales companies in Argentina, Australia, Austria, Belgium, Brazil, Canada, China, Czech Republic, Denmark, Estonia, Finland, France, Germany, Hungary, India, Indonesia, Italy, Netherlands, Norway, Poland, Portugal, Russia, Spain, South Africa, South Korea, Sweden, Switzerland, Thailand, UAE, UK and the US. Sales partners in 65 other countries.

Content

Introduction wall saw blades	04
PREMIUM WSL-ULTRA FAST CUT Wall saw blades	06
PREMIUM WSL-FAST CUT Wall saw blades	07
PREMIUM WSL-FAST CUT-LONGLIFE Wall saw blades	07
PREMIUM WSL Wall saw blades	08
PREMIUM WSM Wall saw blades	09
PREMIUM WSL-SILENT Wall saw blades	11
PREMIUM WSL-FAST CUT-LONGLIFE-SILENT Wall saw blades	11
PREMIUM WSM-SILENT Wall saw blades	11
STANDARD WSL Wall saw blades	12
STANDARD WSM Wall saw blades	13
PREMIUM WSL-DEEP CUT Wall saw blades	14
Application recommendations	16

Pictograms



Wall saw



TGD® –Tyrolit GRAIN DISTRIBUTION

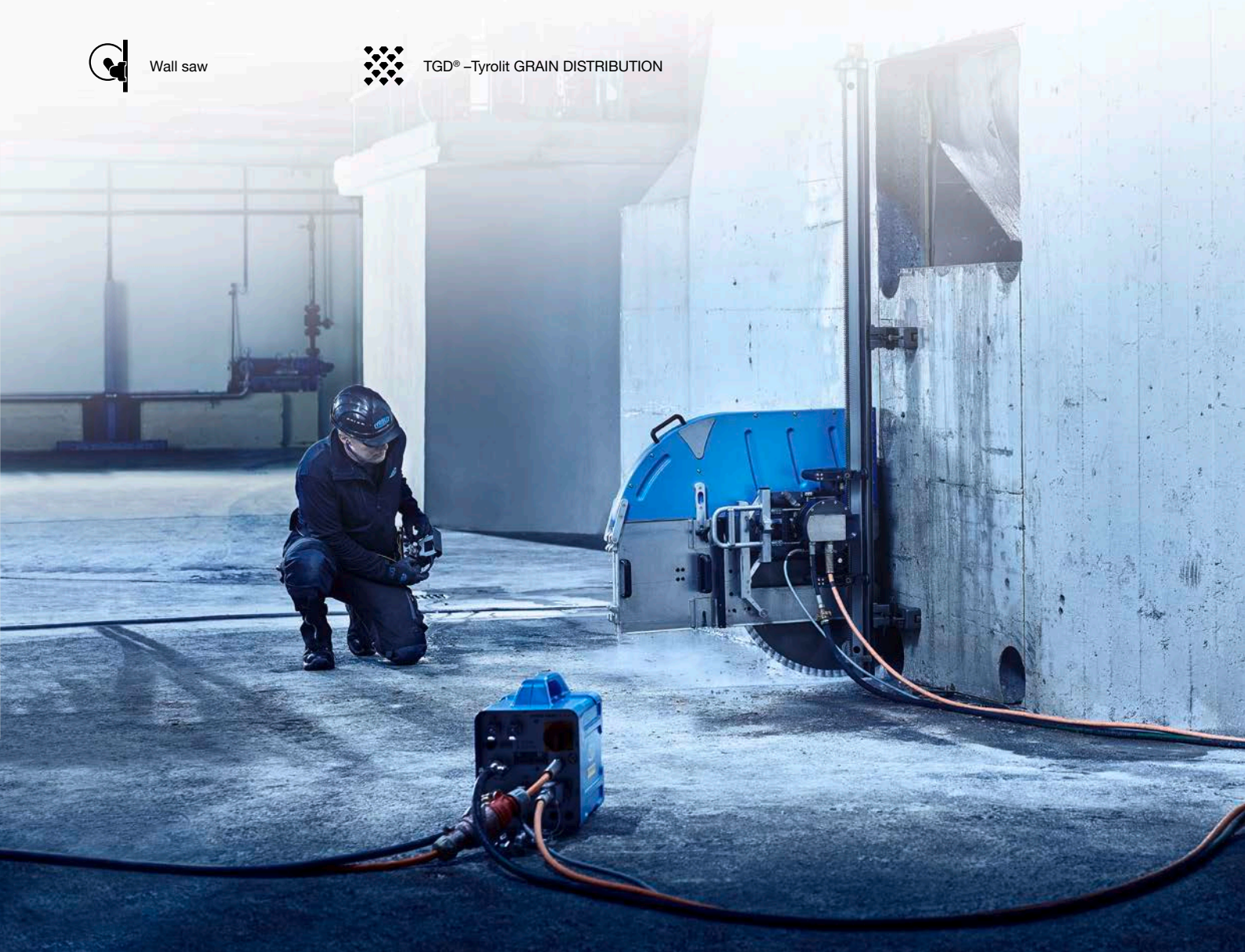

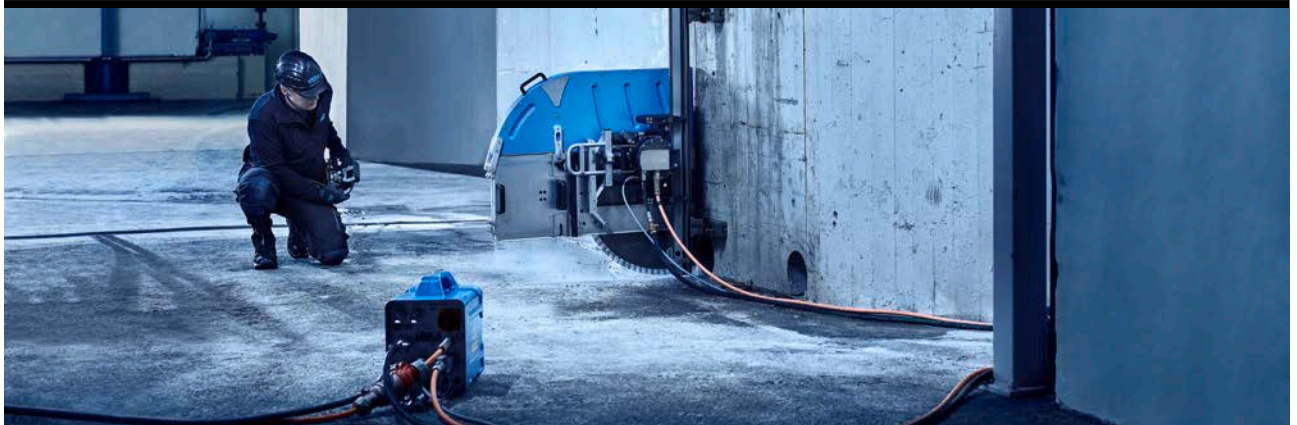

Wall saw blades

Decades of experience in the production and application of wall saw blades and machines give Tyrolit the edge in the marketplace.

The Tyrolit wall saw blades and machines system provides on one side innovative solutions for large scale projects and enables cost effective results for everyday construction use on the other side. Especially suitable

for apertures and openings in walls or ceilings for concrete with or without reinforcement and wall thicknesses up to 100 cm. Tyrolit wall saw blades are designed to work flawlessly with

Tyrolit Hydrostress machines. Wall sawing is a nearly vibration-free process that protects the buildings structure.

Application recommendation & information Tyrolit wall saw blades

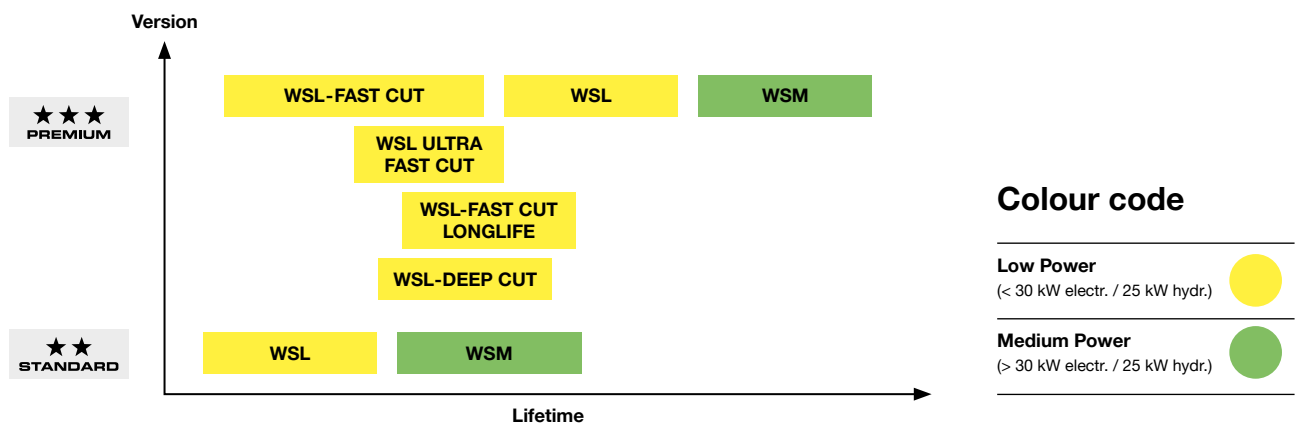

Recommendations

- + Highest levels of performance at peripheral speeds of 35–45 m/s on concrete
- + The correct coolant quantity is also important for optimum cutting performance
- + The machine safety and user instructions must be read and understood before starting work
- + The safety manual will be sent to you on request

Drive holes

Drive holes	Producer	Machines	H	N1	TKD1	BD1	AD1	K	N2	TKD2	BD2	AD2
12M109	Tyrolit	WSE1621, WSE2226, WSE1217, DZ-S2, WZ, FZ-4S* (Not for WSE811 MKII and EX)	60	6	80	10	-	x	6	130	10	16,5 (E ≥ 3,5)
6M247	Tyrolit	WSE1621, WSE2226, WSE1217, DZ-S2, WZ, FZ-4S* (Not for WSE811 MKII and EX)	60	6	130	10	17	-	-	-	-	-
6M199	Tyrolit	WSE811 MKII and EX	60	6	90	10,5	16	-	-	-	-	-
12M255	Tyrolit & HILTI / HUSQVARNA	Tyrolit (Not for WSE811 MKII and EX) & HILTI / HUSQVARNA since 1998 (Not for WS220HF and DS TS 5-SE)	60	6	110	≥ 10,5	21	-	6	130	10	16,5
6M207	HILTI / HUSQVARNA	HUSQVARNA WS "new" (since 1998) (Not for WS220HF) HILTI DS-TS-22 / 30 / 32 "new" (since 1998) DST 10-CA, DST 20-CA (electr.) (Not for DS TS 5-SE)	60	6	110	14	21	-	-	-	-	-
12M112	Tyrolit	Tyrolit, only in Scandinavia	60	6	80	10	-	x	6	108	10,5	20,5
12M221	PENTRUDE	Flange QEF60-108, e.g. LINDGREN	60	6	80	10	-	x	6	108	10	20
6M225	PENTRUDE	Flange QEF60-130, e.g. HYDROTEC	60	6	130	10	17	-	-	-	-	-

Legend

H	Main hole
N	Number of holes
TKD	Pitch diameter
BD	Diameter of the through hole
AD	Outer diameter of the counterbore

K	Cooling hole
*	Blade flange ST cpl. (10977882)

Bores and drive holes for special machines on request.
Details in the table in mm.

Drive holes 12M255

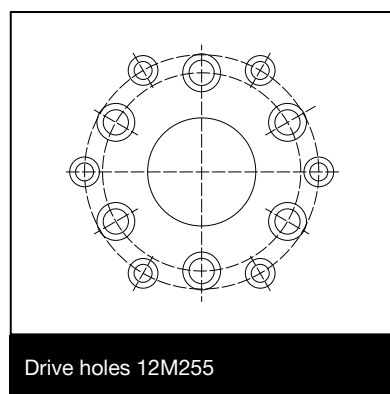

=

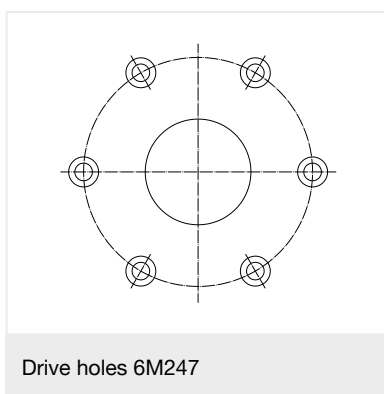

+

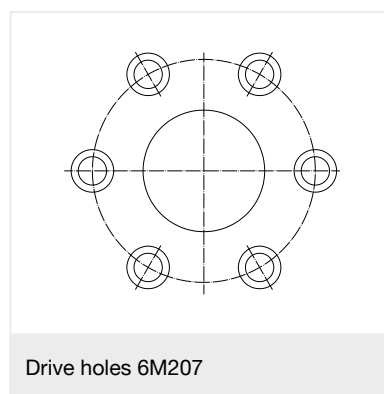

Combination for Tyrolit wall saw heads
in Central Europe (except WSE811 MKII)
and HILTI / HUSQVARNA wall saw heads

For Tyrolit wall saw heads
in Central Europe (except WSE811 MKII)

For HILTI / HUSQVARNA
wall saw heads

6M247 = 12M109
without cooling drive holes



Selection

Quality tools for the most demanding applications and maximum economic efficiency. Laser welded TGD® segments up to incl. Ø 1 200 mm for maximum safety. Noise-reduced version of the steel cores (SILENT edition) available.

WSL-ULTRA FAST CUT Wall saw blades

in TGD®-Technology

+ Consistently very fast cutting performance and noticeable smooth running with TGD®-Technology (Tyrolit GRAIN DISTRIBUTION), a unique technology developed by Tyrolit for the optimised distribution of grain.



+ Highest stock removal rate

For machines up to 20 kW electric / 20 kW hydraulic. Highest cutting performance. Highly recommended for normal infeed depths and very strong reinforcement.



WSL-ULTRA FAST CUT Wall saw blades in TGD®-Technology



	Shape	Type number	Dimension	Drive holes	Segment height
	C7W	34589294	600 × 4.9 × 60	12M255	13
		34589287	650 × 4.9 × 60	12M255	13
		34589790	700 × 4.9 × 60	12M255	13
		34589811	800 × 4.9 × 60	12M255	13
		34589812	825 × 4.9 × 60	12M255	13
		34589813	925 × 4.9 × 60	12M255	13
		34589814	1025 × 4.9 × 60	12M255	13
		34589815	1200 × 4.9 × 60	12M255	13

● = low

● = medium





WSL-FAST CUT Wall saw blades in TGD®-Technology

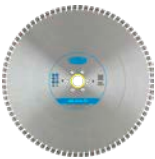

For machines up to 20 kW electric / 20 kW hydraulic.
Extremely high cutting performance.

Highly recommended for heavy reinforcement.



	Shape	Type number	Dimension	Drive holes	Segment height
	 C7W	34336798	600 × 4.9 × 60	6M199	13
		34497746	600 × 4.9 × 60	12M255	13
		34378038	650 × 4.4 × 60	6M199	13
		34549337	650 × 4.9 × 60	12M255	13
		34378037	750 × 4.4 × 60	6M199	13
		34478330	800 × 4.4 × 60	12M255	13
		34541416	800 × 4.9 × 60	12M255	13
		34377291	825 × 3.9 × 60	6M199	13
		34377152	825 × 4.4 × 60	6M199	13
		34475637	825 × 4.4 × 60	12M255	13
		34475635	825 × 4.9 × 60	12M255	13
		34549162	925 × 4.4 × 60	12M255	13
		34549338	925 × 4.9 × 60	12M255	13
		34479554	1000 × 4.4 × 60	12M255	13
		34475636	1025 × 4.4 × 60	12M255	13
		34496902	1025 × 4.9 × 60	12M255	13
		34497747	1200 × 4.4 × 60	12M255	13



WSL-FAST CUT-LONGLIFE Wall saw blades in TGD®-Technology



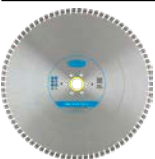

For machines up to 20 kW electric / 20 kW hydraulic. Easy to cut, smooth running and longer lifetime than WSL-FAST CUT.
Excellent for heavy reinforcement.

	Shape	Type number	Dimension	Drive holes	Segment height
	 C71W	34336749	600 × 3.9 × 60	6M199	13
		34549616	600 × 4.9 × 60	12M255	13
		34549620	650 × 4.9 × 60	12M255	13
		34475692	800 × 4.9 × 60	12M255	13
		34475693	825 × 4.4 × 60	12M255	13
		34493780	825 × 4.9 × 60	12M255	13
		34549618	925 × 4.4 × 60	12M255	13
		34475694	1025 × 4.4 × 60	12M255	13
		34493779	1025 × 4.9 × 60	12M255	13
		34549617	1200 × 4.4 × 60	12M255	13

WSL Wall saw blades
 in TGD®-Technology

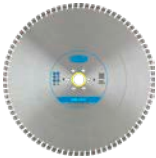
For machines up to 30 kW electric / 25 kW hydraulic. Universal wall saw blade with high cutting performance and long lifetime.



	Shape	Type number	Dimension	Drive holes	Segment height
	 C71W	34018259	600 × 3.9 × 60	6M199	13
		34301250	600 × 4.4 × 60	12M255	13
		34279357	600 × 4.9 × 60	6M225	13
		34018309	600 × 4.9 × 60	12M112	13
		34275378	600 × 4.9 × 60	12M255	13
		34195250	650 × 3.9 × 60	6M199	13
		34195301	650 × 4.4 × 60	6M199	13
		34048045	650 × 4.9 × 60	6M225	13
		34199529	650 × 4.9 × 60	12M255	13
		34186374	700 × 3.9 × 60	6M225	13
		34018269	750 × 3.9 × 60	6M199	13
		34195304	750 × 4.4 × 60	6M199	13
		34359379	800 × 3.9 × 60	12M255	13
		34075186	800 × 4.4 × 60	6M225	13
		34254745	800 × 4.4 × 60	12M255	13
		34234690	800 × 4.9 × 60	6M225	13
		34018313	800 × 4.9 × 60	12M112	13
		34549511	825 × 3.9 × 60	12M255	13
		34208097	825 × 4.4 × 60	12M255	13
		34168251	825 × 4.9 × 60	12M255	13
		34194330	900 × 4.9 × 60	12M255	13
		34254746	925 × 4.4 × 60	12M255	13
		34549515	925 × 4.9 × 60	12M255	13
		34234733	1000 × 4.4 × 60	6M225	13
		34018298	1000 × 4.4 × 60	12M112	13
		34232142	1025 × 4.4 × 60	12M255	13
34430930	1025 × 4.9 × 60	12M255	13		
34179916	1200 × 4.4 × 60	6M225	13		
34018304	1200 × 4.4 × 60	12M112	13		
34194331	1200 × 4.4 × 60	12M255	13		



WSM Wall saw blades in TGD®-Technology



For machines from 20 kW electric / 25 kW hydraulic. Highly recommended for strong machines and abrasive materials.

	Shape	Type number	Dimension	Drive holes	Segment height
	 C71W	34549642	600 × 4.4 × 60	12M255	13
		34018208	600 × 4.4 × 60	12M112	13
		34549643	650 × 4.4 × 60	12M255	13
		34244855	650 × 4.9 × 60	12M255	13
		34018224	650 × 4.9 × 60	12M112	13
		34549644	700 × 4.4 × 60	12M255	13
		34018227	700 × 4.4 × 60	12M112	13
		34549645	750 × 4.4 × 60	12M255	13
		34018229	750 × 4.4 × 60	12M112	13
		34549646	800 × 4.4 × 60	12M255	13
		34018241	800 × 4.4 × 60	12M112	13
		34517568	800 × 4.9 × 60	12M255	13
		34018243	800 × 4.9 × 60	12M112	13
		34244861	825 × 4.4 × 60	12M255	13
		34244853	825 × 4.9 × 60	12M255	13
		34549648	925 × 4.4 × 60	12M255	13
		34549649	1000 × 4.4 × 60	12M255	13
		34018251	1000 × 4.4 × 60	12M112	13
		34244857	1025 × 4.4 × 60	12M255	13
		34549647	1025 × 4.9 × 60	12M255	13
34244856	1200 × 4.4 × 60	12M255	13		
34018255	1200 × 4.4 × 60	12M112	13		

WSM wall saw blades in 5.4, 5.9 and 6.5 mm segment width on request. For the perfect precut.

SILENT Wall saw blades

Noise-damped steel cores for optimum vibration damping. Ideal for use in noise-sensitive areas. The 10 decibel reduction in noise level is perceived by humans as a 50% noise reduction.

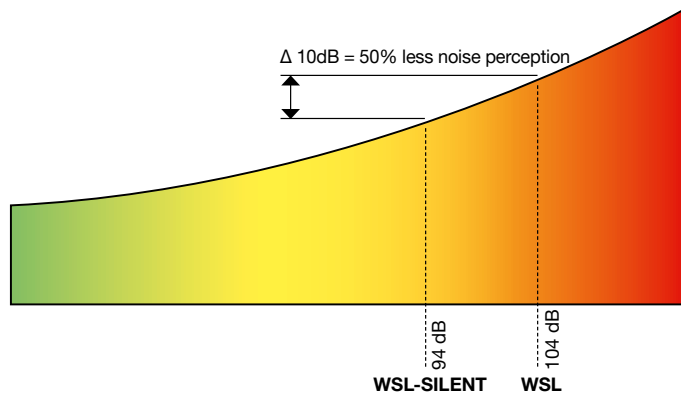



Even if the noise is perceived to be reduced by 50%, the prescribed personal protective equipment (PPE) must be used during the operation.



WSL-SILENT Wall saw blades
in TGD®-Technology







For machines up to 20 kW electric. High cutting performance with long lifetime.



Shape	Type number	Dimension	Drive holes	Segment height
  C71GW	34018152	600 × 4.4 × 60	6M199	13
	34253285	600 × 4.4 × 60	6M225	13
	34359351	600 × 4.4 × 60	6M247	13
	34359353	600 × 4.9 × 60	6M247	13
	34018159	600 × 4.9 × 60	12M112	13
	34195471	650 × 4.4 × 60	6M199	13
	34287229	650 × 4.4 × 60	6M225	13
	34549638	650 × 4.9 × 60	6M247	13
	34018166	700 × 4.4 × 60	12M112	13
	34195605	750 × 4.4 × 60	6M199	13
	34197742	800 × 4.4 × 60	6M207	13
	34253286	800 × 4.4 × 60	6M225	13
	34359356	800 × 4.4 × 60	6M247	13
	34018170	800 × 4.4 × 60	12M112	13
	34359358	800 × 4.9 × 60	6M247	13
	34018174	800 × 4.9 × 60	12M112	13
	34040269	825 × 4.4 × 60	6M207	13
	34366463	825 × 4.4 × 60	6M247	13
	34444588	825 × 4.9 × 60	6M247	13





◀



★★★ PREMIUM  **WSL-SILENT Wall saw blades**
in TGD®-Technology  

	Shape	Type number	Dimension	Drive holes	Segment height
		34018177	1000 × 4.4 × 60	12M112	13
		34444590	1025 × 4.4 × 60	6M247	13
		34359373	1200 × 4.4 × 60	6M247	13
		34018183	1200 × 4.4 × 60	12M112	13



★★★ PREMIUM  **WSL-FAST CUT-LONGLIFE-SILENT Wall saw blades**
in TGD®-Technology  

For machines up to 20 kW electric. Very high cutting performance and lifetime.

	Shape	Type number	Dimension	Drive holes	Segment height	
		C71	34549636	825 × 4.4 × 60	6M247	13
		34549635	825 × 4.9 × 60	6M247	13	
		34549634	825 × 5.9 × 60	6M247	13	
		34549398	1025 × 4.4 × 60	6M247	13	
		34549637	1200 × 4.4 × 60	6M247	13	

★★★ PREMIUM  **WSM-SILENT Wall saw blades**
in TGD®-Technology  

For machines up to 20 kW electric. Ideal for abrasive materials.

	Shape	Type number	Dimension	Drive holes	Segment height	
		C71GW	34242048	600 × 4.4 × 60		13
		34419194	650 × 4.9 × 60		13	
		34356569	700 × 4.4 × 60		13	
		34549654	750 × 4.4 × 60	6M247	13	
		34242053	800 × 4.4 × 60		13	
		34475704	825 × 4.4 × 60	6M247	13	
		34242054	1000 × 4.4 × 60		13	
		34475705	1025 × 4.4 × 60	6M247	13	

● = low

● = medium



Selection

Quality tools for daily use. Cutting speed and lifetime in a convincing ratio.
Laser-welded TGD® segments up to incl. Ø 1 200 mm for highest safety.

WSL Wall saw blades

in TGD®-Technology

+ **TGD®-Technology** (Tyrolit GRAIN DISTRIBUTION), a unique technology developed by Tyrolit for the optimised distribution of grain.





+ **Convincing ratio of cutting performance and lifetime.**

For machines up to 20 kW electric / 20 kW hydraulic.



WSL Wall saw blades in TGD®-Technology





	Shape	Type number	Dimension	Drive holes	Segment height
	 C7W	34359385	600 × 3.9 × 60	12M255	13
		34017389	600 × 4.4 × 60	12M112	13
		34313605	600 × 4.4 × 60	12M255	13
		34017402	600 × 4.9 × 60	12M112	13
		34359386	600 × 4.9 × 60	12M255	13
		34195305	650 × 3.9 × 60	6M199	13
		34195307	650 × 4.4 × 60	6M199	13
		34549400	650 × 4.9 × 60	12M255	13
		34359389	700 × 4.4 × 60	12M255	13
		34017404	750 × 3.9 × 60	6M199	13
		34017406	800 × 4.4 × 60	12M112	13
		34359391	800 × 4.4 × 60	12M255	13
		34359392	800 × 4.9 × 60	12M255	13
		34542169	825 × 3.9 × 60	12M255	13
		34017408	825 × 4.4 × 60	12M112	13
		34325781	825 × 4.4 × 60	12M255	13





◀

★★
STANDARD

● WSL Wall saw blades
in TGD®-Technology



	Shape	Type number	Dimension	Drive holes	Segment height
		34506340	825 × 4.9 × 60	12M255	13
		34017412	1000 × 4.4 × 60	12M112	13
		34359393	1000 × 4.4 × 60	12M255	13
		34444641	1025 × 4.4 × 60	12M255	13
		34017416	1200 × 4.4 × 60	12M112	13
		34359394	1200 × 4.4 × 60	12M255	13

★★
STANDARD

● WSM Wall saw blades
in TGD®-Technology



For machines from 20 kW electric / 25 kW hydraulic. Good cutting performance in a convincing ratio to lifetime.

	Shape	Type number	Dimension	Drive holes	Segment height	
		C7W	34549420	600 × 4.4 × 60	12M255	13
		34017419	600 × 4.4 × 60	12M112	13	
		34549421	650 × 4.9 × 60	12M255	13	
		34549422	750 × 4.4 × 60	12M255	13	
		34017424	750 × 4.4 × 60	12M112	13	
		34017428	825 × 4.4 × 60	12M112	13	
		34436519	825 × 4.4 × 60	12M255	13	
		34475713	825 × 4.9 × 60	12M255	13	
		34549423	925 × 4.4 × 60	12M255	13	
		34549424	925 × 4.9 × 60	12M255	13	
		34017433	1000 × 4.4 × 60	12M112	13	
		34017435	1025 × 4.4 × 60	12M112	13	
		34475714	1025 × 4.4 × 60	12M255	13	
		34485561	1025 × 4.9 × 60	12M255	13	
		34485500	1200 × 4.4 × 60	12M255	13	
		34017438	1200 × 4.4 × 60	12M112	13	

● = low

● = medium

DEEP CUT Wall saw blades

The WSL-DEEP CUT series: It provides wide segments at the beginning and can go blade wise narrower to the wanted cutting depth. This ensures a good opening on both sides of the steel core and for his reason the cooling water reaches the diamond segment in a good manner. Diameters of up to 2 500 mm are available on request.

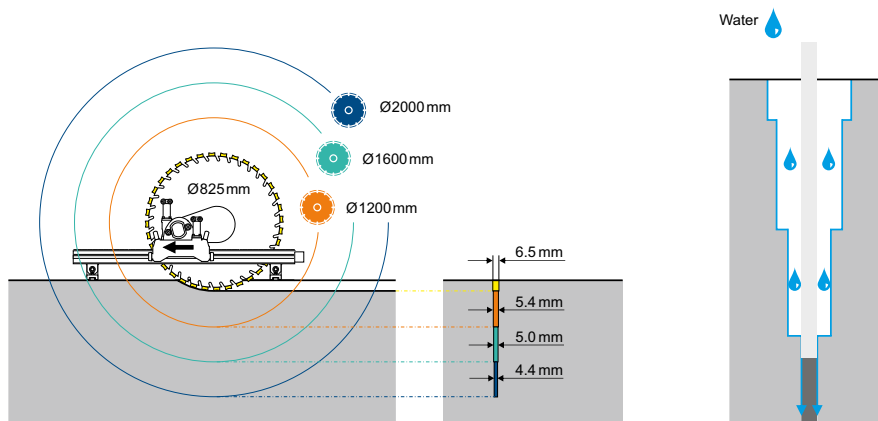

WSL-DEEP CUT Wall saw blades



WSL-DEEP CUT Wall saw blades
in TGD®-Technology



For machines from 17 kW electric / 20 kW hydraulic. Quality tools for the greatest cutting depths in wall sawing.



	Shape	Type number	Dimension	Drive holes	Segment height
	 C7W Laser welded segments with TGD®-Technology	34415642	825 × 5.9 × 60	12M255	13
		34497741	825 × 6.5 × 60	12M255	13
		34521389	1025 × 5.4 × 60	12M255	13
		34422925	1200 × 4.9 × 60	12M255	13
		34497743	1200 × 5.4 × 60	12M255	13
		NEW 34541790	1600 × 4.4 × 60	12M255	13
 C4 Brazeed segments		34415649	1400 × 4.4 × 60	12M255	13
		34379300	1500 × 4.4 × 60	12M109	13
		34488100	1500 × 4.4 × 60	12M255	13
		34379257	1600 × 4.4 × 60	12M109	13
		34488121	1600 × 4.4 × 60	12M255	13
		34450071	1600 × 5 × 60	12M109	13
		34450072	1600 × 5.6 × 60	12M109	13





WSL-DEEP CUT Wall saw blades in TGD®-Technology



	Shape	Type number	Dimension	Drive holes	Segment height
	 C4	34379258	1800 × 4.4 × 60	12M109	13
		34488122	1800 × 4.4 × 60	12M255	13
		34379341	2000 × 4.4 × 60	12M109	13
		34379342	2200 × 4.4 × 60	12M109	13
		34500293	2200 × 4.4 × 60	12M255	13

WSL-DEEP CUT up to Ø 1 200 mm in 5.4, 5.9 and 6.5 mm segment widths possible.
From Ø 1 350 mm in 5.0 and 5.6 mm segment widths.
For optimum gradation of the deep cut set.

● = low

● = medium



Application recommendations

Wall saws and wall saw blades



WALL SAW ▶	PREMIUM WSE811 MKII	PREMIUM WSE1217	PREMIUM WSE1621	PREMIUM WSE2226	DZ-S2		FZ-4S
DRIVE ▶					PREMIUM PPH20	PREMIUM / STANDARD PPH25	PREMIUM PPH25 PPH40
QUALITY LINES	WALL SAW BLADE ▼						
WSL-FCX	◐	○	●		●	●	
WSL-FC	●	●	●	○	●	●	
WSL-FC-LL	●	●	●	○	●	●	
WSL	◐	●	●	○	●	●	●
WSM		◐	◐	●	○		
WSL-SILENT	●	●	●		○		
WSL-FC-LL-SILENT	●	●	●		○		
WSM-SILENT		◐	◐		○		
WSL	●	●	●	○	●	◐	
WSM		◐	◐	●	○	●	●
WSL-DC		○	●	●	●	●	●

★★★
PREMIUM

★★
STANDARD

★★★
PREMIUM

FCX ULTRA FAST CUT
FC FAST CUT
LL LONG LIFE
DC DEEP CUT

● Optimal
○ Good
◐ Acceptable
 Not suitable

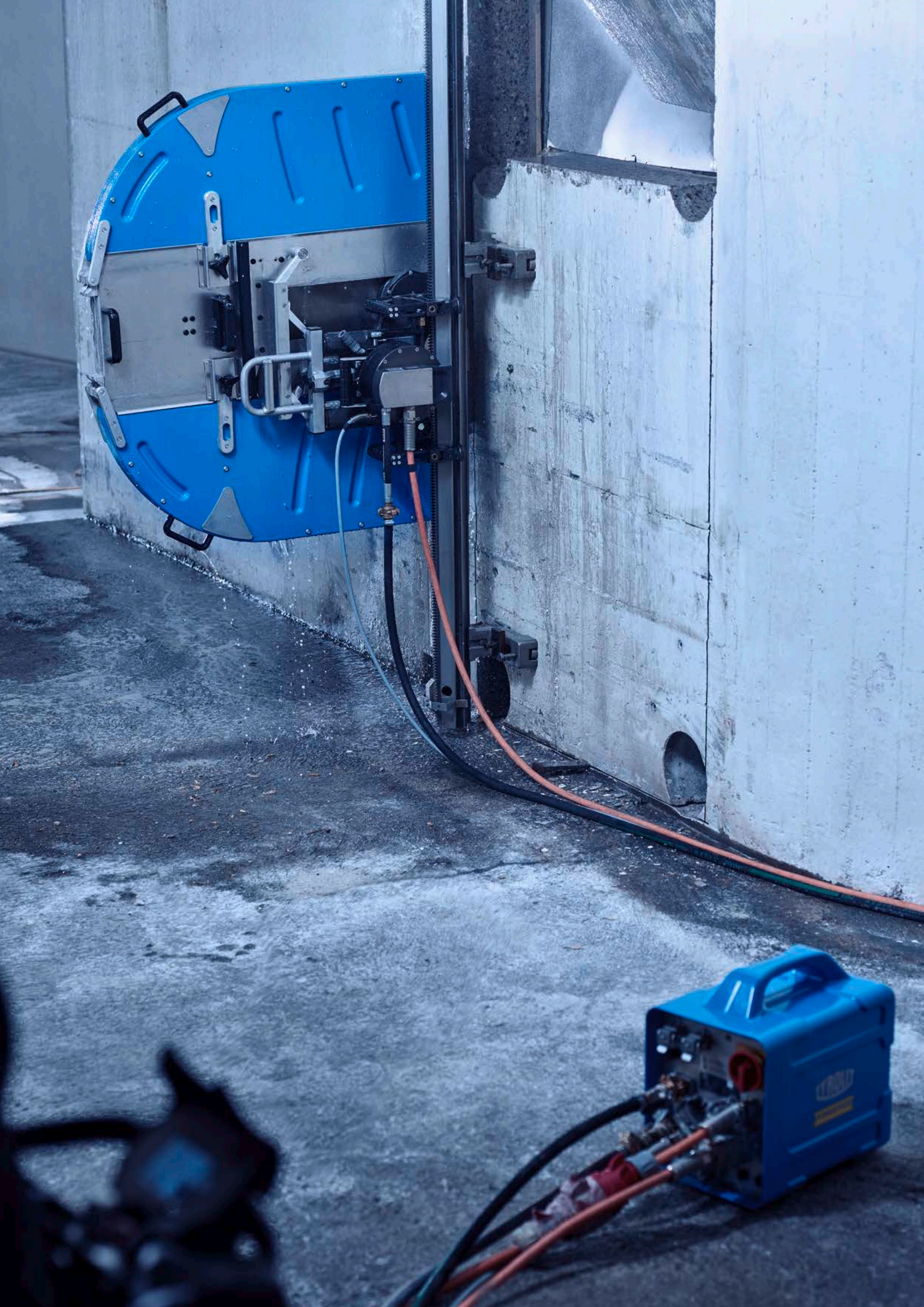

Tyrolit Construction Products GmbH

Swarovskistraße 33 | 6130 Schwaz | Austria

Tel +43 5242 606-0 | Fax +43 5242 63398

Our **worldwide subsidiary companies** can be found
on our website at www.tyrolit.com



Find us on social media
TYROLITgroup