



**TYROLIT - YOUR PARTNER IN THE
BEARING INDUSTRY**
GRINDING TOOLS FOR ROLLER BEARING
RINGS AND ROLLERS.

A Company of the SWAROVSKI Group
www.tyrolit.com

TYROLIT

TYROLIT Group

A global company

As one of the world's leading manufacturers of bonded grinding, cutting, sawing, drilling and dressing tools as well as a system supplier of tools and machines for the construction industry, the family-run company TYROLIT has been synonymous with top quality products, innovative spirit and outstanding service since 1919.

Day in, day out, the experts at TYROLIT work on delivering tailor-made solutions for customers around the world, helping to make their businesses successful. Around 80,000 available products set the standards in a wide variety of industries.



TYROLIT company headquarters in Schwaz, Austria

TYROLIT business units



Metal / Precision

From precision machining in the engine and gearbox industry to the production of cut-off wheels with diameters up to 2,000 mm for the steel industry – the TYROLIT product range in the Metal & Precision business unit includes high-tech tools for a wide variety of applications.



Trade

Thanks to its global sales network, in addition to premium product solutions in the three core areas of cutting, grinding and surface treatment, the trade business unit of TYROLIT guarantees truly customer-focused marketing support.



Construction

In the Construction business unit, TYROLIT is a leading system supplier of drilling systems, wall and wire saws, floor saws and tools for the surface grinding of concrete motorways.

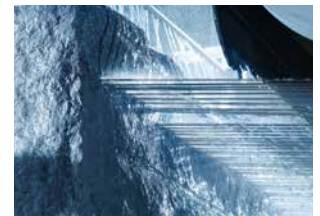

Stone – Ceramics – Glass

Our tailored diamond tools and grinding solutions in the Stone – Ceramics – Glass business unit impress through their exceptional performance and quality.

A competent partner in the bearing industry

TYROLIT supplies tools for high-precision components, for example rolling bearings, which are manufactured in sequential production. For the particularly high quality requirements of these customised products in terms of roundness, harmonic undulations, surface finish, as well as dimensional and shape accuracy, grinding tools of the highest quality are required.

For decades, the TYROLIT Group has successfully been working on the development of these specialised tools and is today one of the world's leading suppliers to the bearing industry. The TYROLIT range includes all products used for grinding and honing rolling bearing rings and rollers.

Our services for the bearing industry at a glance

Product quality

Global presence

Application-specific
solutions

Application
technology



Global presence In your vicinity

Global presence

TYROLIT stands for global thinking and activities. With a worldwide sales network currently in 65 countries and with our own production plants in 12 countries on five continents, we offer our customers all the advantages of a globally operating company.

Local availability

Global thinking, local action – in your national language and in your vicinity. This is the principle we follow in dealing with our customers. Local contacts near your premises and a global team of specialist application engineers ensure optimum customer support and first-class service.

Your benefits

- + Global presence with local contacts
- + Short response and service times

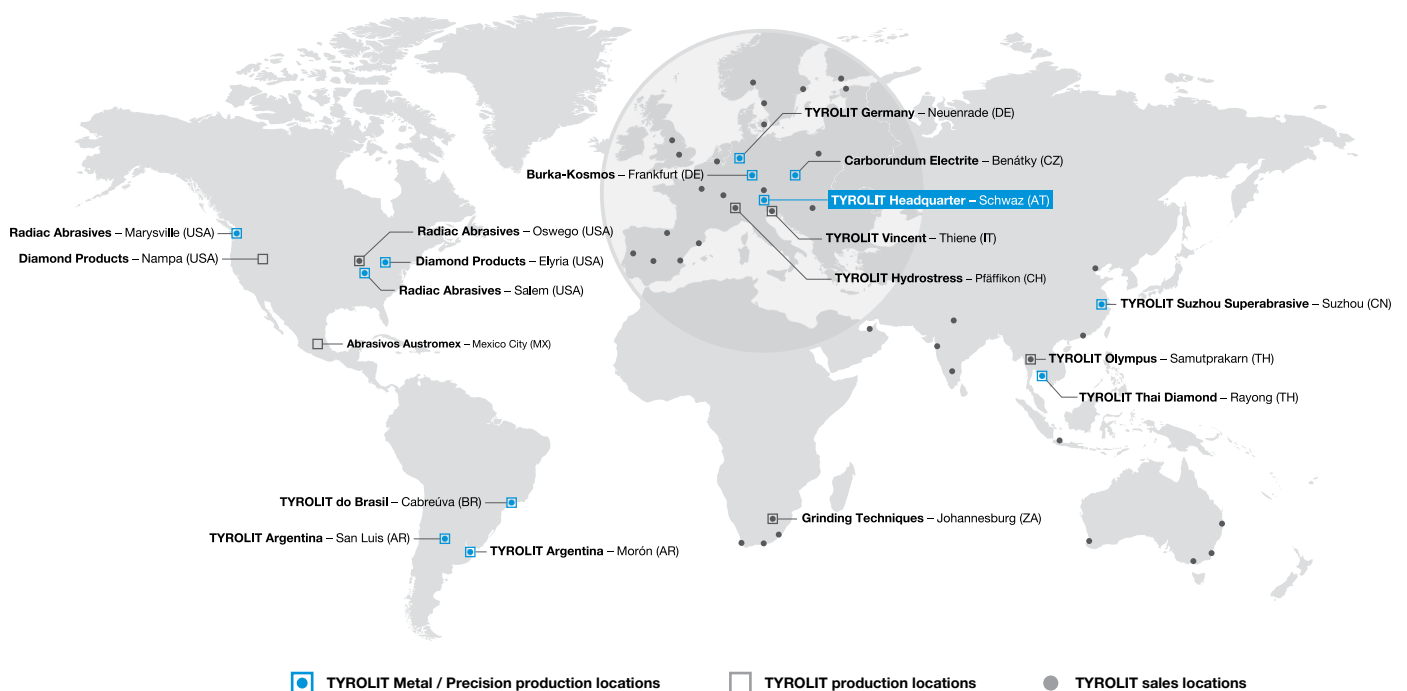

Application technology

Best grinding solutions for your processes

Grinding expertise – this has characterised TYROLIT for nearly one hundred years. With the wealth of process expertise commanded by our specialist application engineers, we are able to provide our customers with sustained solutions in line with their demanding technical and economic expectations.

Our global team of specialist application engineers defines solution proposals individually tailored to your requirements. As a result, we guarantee our customers an optimally adapted and cost-effective grinding process at all times.

Your benefits

- + The global presence of our application engineers
- + Process solutions and optimisation for individual tasks
- + Cooperation with established machine manufacturers
- + Internal and external seminars and training courses







Application-specific solutions Tailored for your industry

In the bearing industry, the grinding and superfinishing play a decisive role due to highest demands in terms of quality and efficiency.

In order to ensure the best possible solution for your production, TYROLIT offers individually developed products for the various grinding applications.

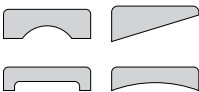
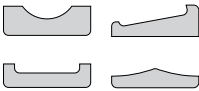
An overview of the available grinding tools for machining rolling bearings is provided below.

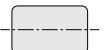
Please see the following pages for detailed descriptions of these tools as well as their respective fields of application.

Component	Grinding position	Grinding process	Product recommendation
 Outer rings	Faces External diameter Track	Surface grinding Centreless grinding Internal cylindrical grinding Superfinishing	CENTURIA CSS ULTRA, CSS REGULATOR COLUMBIA, COLUMBIA SA TYROLIT SUPERFINISHING STONES
 Internal rings	Faces Track Bore	Surface grinding External cylindrical grinding Superfinishing Internal cylindrical grinding	CENTURIA CSS ULTRA TYROLIT SUPERFINISHING STONES COLUMBIA, COLUMBIA SA
 Taper rollers	External diameter Faces	Centreless grinding Surface grinding	TYROLIT ELASTIC WHEELS CENTURIA
 Cylindrical rollers	External diameter Faces	Centreless grinding Surface grinding	TYROLIT SICA WHEELS CENTURIA
 Spherical rollers	External diameter Faces	External cylindrical grinding Surface grinding	CSS ULTRA CENTURIA

A photograph of an industrial grinding machine. The machine is primarily blue and silver, with several large, cylindrical grinding wheels mounted on a blue metal frame. The wheels are arranged in a row, and some are partially obscured by others. In the background, there are various pipes, valves, and a red control panel with a yellow warning sign that reads "Achtung! NOT AUS GT-01". The overall scene is a well-lit industrial environment.

Grinding tools for the bearing industry

Surface grinding of rings and rollers

Double side face grinding

Machines for double side face grinding are equipped with a vertically or horizontally positioned pair of grinding discs. Both faces of the rings and rollers are ground simultaneously. This machine concept is excellently suited in order to produce plane-parallel parts with a high level of precision and productivity.

Machining processes:

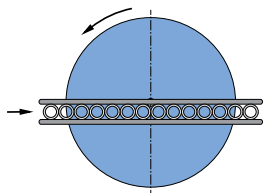

Straight through-feed grinding

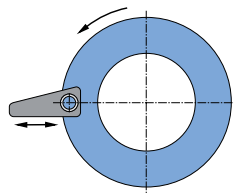

Plunge cut grinding

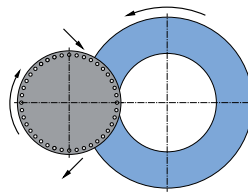

Star-shaped through-feed grinding

Special processes

Taper rollers are convex-ground on only one side. This is done in special machines, either with cup wheels or profiled peripheral wheels.

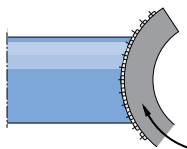

Face grinding of taper rollers with profiled peripheral wheels

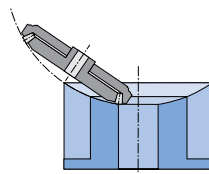

Face grinding of taper rollers with cup wheels

CENTURIA

Resin-bonded grinding tools for face grinding

With its CENTURIA product line, TYROLIT offers a complete range of conventional, resin-bonded tools for surface grinding. Different surface grinding methods are used for the efficient production of functional surfaces that must satisfy exacting requirements in terms of flatness, plane parallelism and surface finish.



Your benefits

- + Long lifetime of the grinding tool
- + Cool grinding, no burning
- + Constant grinding behaviour

Further products:

- Vitrified-bonded grinding discs for special applications
- CBN grinding discs in resin or vitrified bonds for small rings and rollers
- CBN lapping discs

Lapping

To meet the highest demands in terms of dimensional accuracy, lapping machines are also used, which are generally equipped with vitrified bonded CBN wheels. The components are located in cages and rotate in a planetary motion between the two CBN wheels until the desired dimension is achieved. This principle enables a better surface finish and maximum precision with regard to dimensional tolerances.

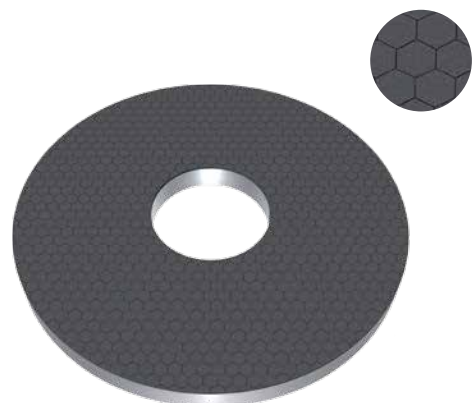

External cylindrical grinding of rings and rollers

Centreless through-feed grinding

This process is used to grind straight outer-ring, cylindrical-roller and taper-roller geometries. The high demands in terms of roundness and harmonic undulations can be manufactured with a high level of productivity.

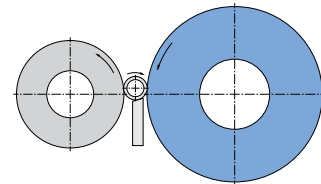

Special processes

Centreless through-feed grinding of taper rollers:

In this process, a profiled steel wheel is used as a regulating wheel so that the rollers are positioned straight against the wheel.

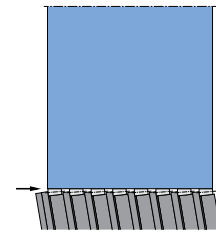

Centreless plunge cut grinding

This process is used to grind profiled parts such as water pump shafts.



External cylindrical plunge grinding

The various track profiles of the inner rings as well as the profile of the barrel rollers are ground using the plunge cut grinding process. In order to meet the high demands with regard to roundness and harmonic undulations, the rings are mounted on sliding shoes (shoe grinding process).

For barrel rollers, regulating wheels are often used in place of the sliding shoes.

The grinding shoes employed must be characterised by good profile retention as well as cool grinding in order to meet the high quality requirements in terms of roundness, harmonic waviness, as well as shape and position tolerances in the shortest possible cycle time.

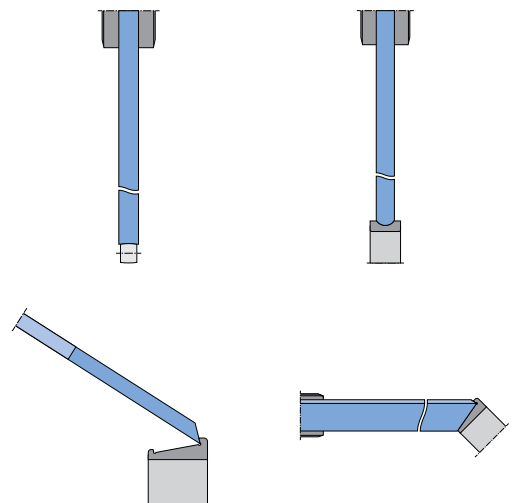

CSS ULTRA

High-performance grinding tools for external cylindrical and centreless grinding

With CSS ULTRA, TYROLIT has succeeded in creating a durable grinding wheel micro-architecture using new high-quality components and innovative sintering technology. This enables the abrasive grain to withstand much greater stresses during use without breaking away prematurely. These improvements result in maximum profile retention combined with minimal wear.



Your benefits

- + Shorter grinding time / higher productivity:
- + Cool grinding, no burning
- + Long lifetime / good profile retention
- + Approved up to 125 m/s

CSS REGULATOR

The regulating wheel for centreless grinding

Through the use of centreless, through-feed and plunge cut grinding, round components can be produced with particular precision and efficiency. Here, the regulating wheel controls the grinding process and therefore has a decisive influence on the quality of the produced components.



Your benefits

- + Excellent profile retention
- + High coefficient of friction
- + Constant grinding pressure

Internal cylindrical grinding of rings

Internal cylindrical plunge grinding

Depending on the bearing type, the race of the outer ring has different profile geometries. These are ground concentrically to the external diameter using the shoe grinding process. High demands are placed on the grinding wheels used in terms of profile retentions and cool grinding behaviour. Even stock removal fluctuations during premachining must be compensated for without interrupting the process.

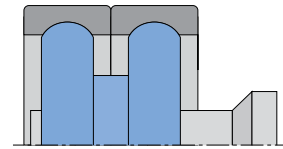

Special processes

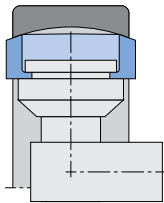

Grinding of the spherical bearing outer ring using an angle spindle and cup wheel

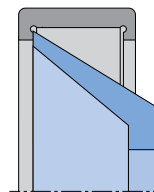

Grinding of cylindrical roller bearing outer ring flanges using a cup wheel

Internal cylindrical grinding

The straight bore is created by oscillating plunge grinding using the shoe grinding process. This grinding process is used in the same manner for most bearing types.

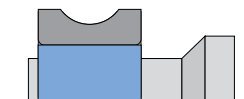

COLUMBIA

Vitrified bonded sintered aluminium oxide grinding tools for internal cylindrical grinding

COLUMBIA grinding wheels from TYROLIT bridge the technological gap between grinding tools made of fused aluminium oxide and superabrasives. For internal cylindrical grinding applications, in particular, these products of specially bonded sintered aluminium oxide develop their full potential and make possible previously unparalleled levels of performance.



Your benefits

- + High quality of the ground rings
- + The best economic efficiency
- + Maximum process stability

COLUMBIA SA

Vitrified bonded CBN grinding tools for internal cylindrical grinding

With COLUMBIA SA, TYROLIT has created an innovative product line for internal cylindrical and profile grinding with CBN. The VCSA bond, which was specially developed for this purpose, further enhances the properties of CBN. The narrow usable dimensional range with internal cylindrical grinding is particularly suitable for the economical use of CBN grinding wheels



Your benefits

- + Good cool grinding behaviour
- + Improved economic efficiency
- + Maximum process stability
- + Suitable for oil and emulsion

Superfinishing of rings and rollers

Plunge superfinishing

This process is used for the tracks of the inner and outer rings as well as for the barrel rollers. With superfinishing, these profiles receive their final shape and surface finish. Depending on the requirements, this processing takes place at one or two stations (pre and finish-machining). The good quality of the superfinishing stone used is of crucial importance for the quality of the bearing in terms of smoothness and durability.

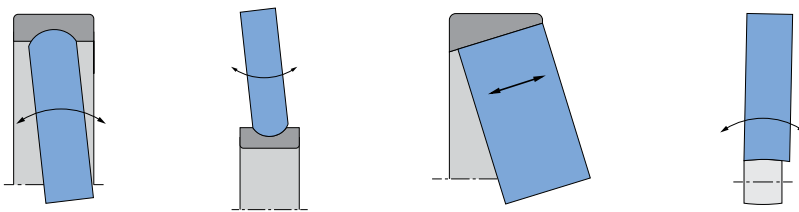

Through-feed superfinishing

Through-feed superfinishing is used for cylindrical and taper rollers. This process is also used for rings with straight tracks or higher requirements with regard to the external diameter. The components are transported via steel rollers. These feature a profile in order to ensure the required crowning of the parts in the micrometre range.

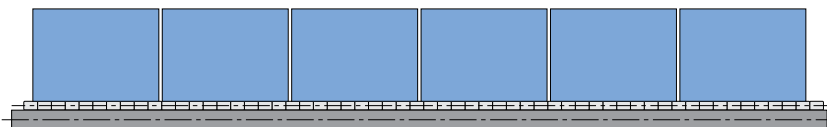

TYROLIT SUPERFINISHING STONES

Vitrified and resin-bonded tools for superfinishing

Honing and superfinishing stones are made from conventional abrasives (aluminium oxide and silicon carbide) as standard. However, Tyrolit also produces these tools using superabrasives (diamond and CBN). Tyrolit superfinishing stones are manufactured using a special production process. Here, superfinishing-stone blocks are produced with maximum homogeneity in terms of hardness and density across the entire cross-section.



Your benefits

- + Consistent quality
- + Good surface finish
- + Good stock removal

TYROLIT SCHLEIFMITTELWERKE SWAROVSKI K.G.

Swarovskistrasse 33 | 6130 Schwaz | Austria

Tel. +43 5242 606-0 | Fax +43 5242 63398

All **worldwide subsidiary companies** can be found on our website at www.tyrolit.com



Like us on Facebook
facebook.com/TYROLIT